

PUMP SPECS SHEET **Model: TAM 1315**



DATI TECNICI SPECIFICATIONS

DIAMETRO PISTONE PISTON DIAMETER	18	mm
CORSA STROKE	12.4	mm
NUMERO PISTONI NUMBER OF PISTONS	3	
REGIME DI ROTAZIONE MASSIMO MAX. SPEED	1725	RPM
PRESSIONE MASSIMA MAX. PRESSURE	150	Bar
	2175	PSI
PORTATA A PRESSIONE MASSIMA FLOW RATE AT MAX. PRESSURE	15.2	l/min.
	4.0	GPM
PRESSIONE MINIMA IN ASPIRAZIONE MIN. INLET PRESSURE	-0,1	bar
	-1.5	PSI
PRESSIONE MASSIMA IN ASPIRAZIONE MAX. INLET PRESSURE	6	bar
	87	PSI
TEMPERATURA MASSIMA ACQUA IN ASPIRAZIONE INLET WATER MAX. TEMPERATURE	85	°C
	185	°F
POTENZA MASSIMA ASSORBITA POWER REQUIREMENT	4.5	kW
	6.0	HP
DIAMETRO ALBERO SHAFT DIAMETER	24	mm
DIAMETRO IN ASPIRAZIONE SUCTION DIAMETER	1/2	BSP
DIAMETRO IN MANDATA OUTLET DIAMETER	3/8	BSP
OLIO SAE 75W90 CRANKCASE OIL SAE 75W90	0.7	l
	0.18	U.S.G.
PESO UNIT WEIGHT	10.6	kg
	23.3	lbs

CARATTERISTICHE FEATURES

- CARTER IN LEGA DI ALLUMINIO PRESSOFUSO
- COMPACT DIE CAST ALUMINIUM CRANKCASE FOR HIGH STRENGTH
- TESTATA STAMPATA IN ACCIAIO INOX AISI 316
- FORGED PUMP HEAD MADE OF AISI 316 STAINLESS STEEL
- ALBERO A GOMITI IN ACCIAIO FORGIATO
- FORGED STEEL CRANKSHAFT INCREASES LOAD RESISTANCE
- CUSCINETTI A RULLI CILINDRICI SOVRADIMENSIONATI
- PREMIUM OVERSIZED ROLLER BEARINGS
- BIELLE IN LEGA SPECIALE ANTIFRIZIONE
- SPECIAL ANTI-FRICTION LIGHT ALLOY CONNECTING RODS
- GUIDE PISTONE IN ACCIAIO INOX
- STAINLESS STEEL PLUNGER RODS
- PISTONI IN CERAMICA AD ELEVATA FINITURA SUPERFICIALE
- HIGHLY POLISHED CERAMIC PISTONS
- VALVOLE IN ACCIAIO INOX AISI 316
- EFFICIENT VOLUMETRIC AISI 316 STAINLESS STEEL CHECK VALVES
- GUARNIZIONI DI ALTA PRESSIONE CON SPECIALE MESCOLA ANTIUSURA ED ANELLO ANTIESTRUSIONE IN TEFLON. GUARNIZIONI DI BASSA PRESSIONE IN TEFLON ENERGIZZATO PER ACQUA CALDA
- HIGH PRESSURE SUPER "U" SEALS MADE OF SPECIAL COMPOUND TO REDUCE WEAR, AND TEFLON REINFORCED ANTI-EXTRUSION RING. LOW PRESSURE SEALS MADE OF ENERGIZED TEFLON FOR HOT WATER

PUMP SPECS SHEET TAM 1315

PUMP SPECS SHEET

CURVE DI PRESTAZIONI

PERFORMANCE CURVES

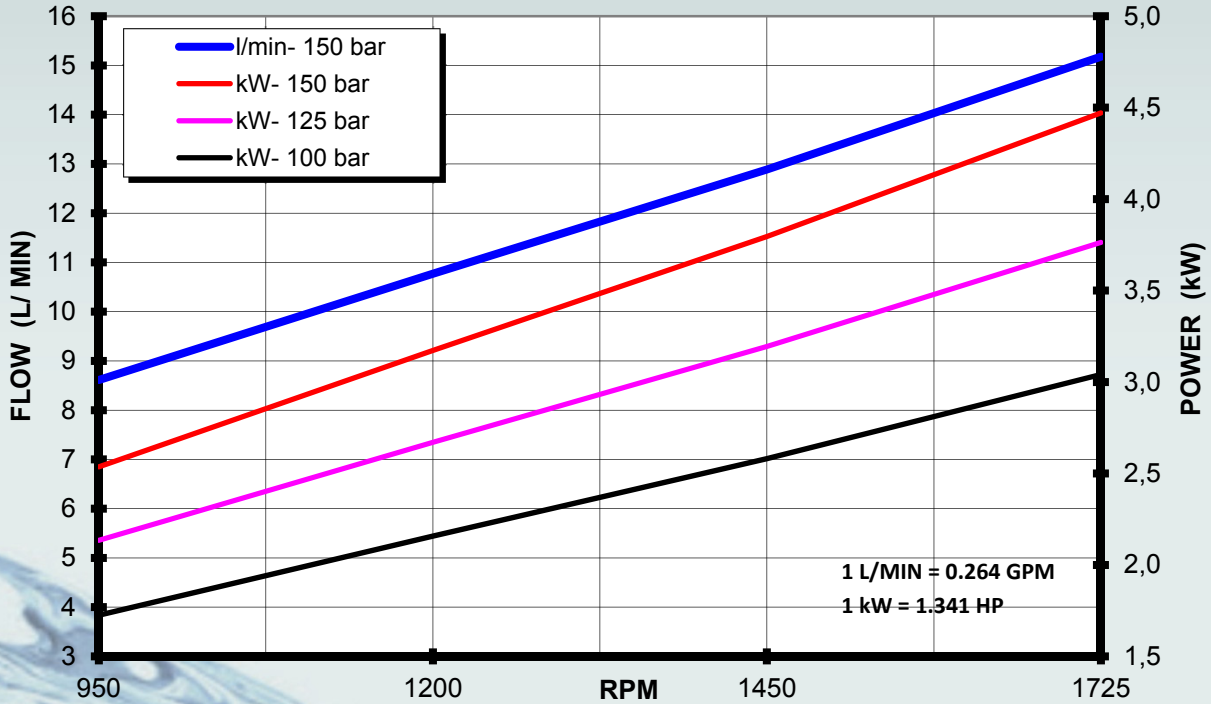

DIMENSIONI DI INGOMBRO

DIAGRAM DIMENSIONS

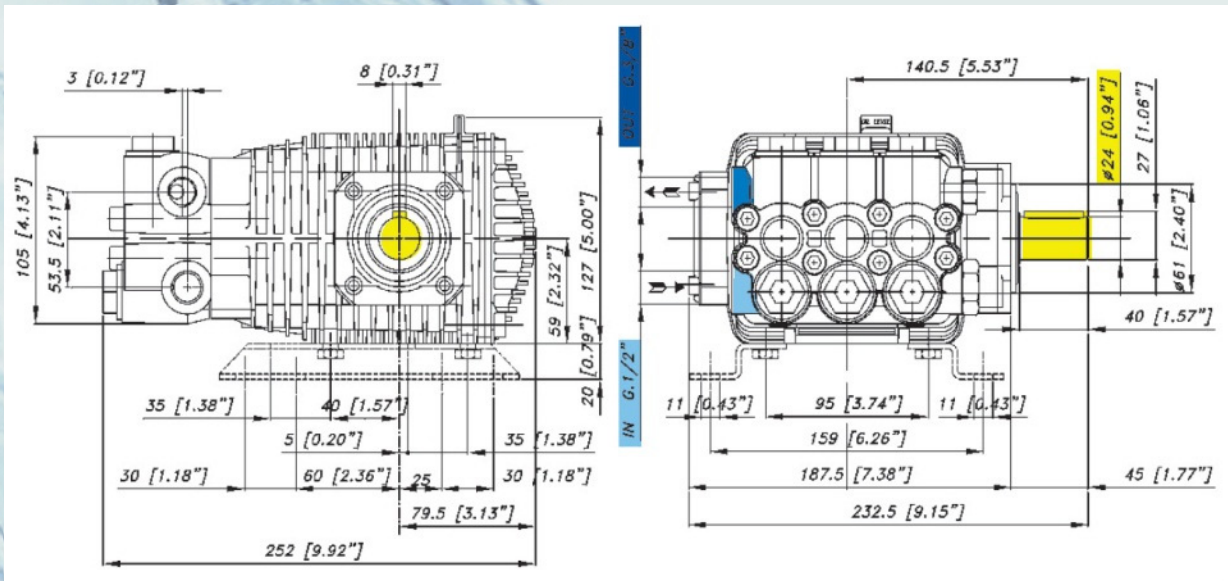

KIT PIEDINI COD. 07.9802.97.3 (OPTIONAL)
MOUNTING RAILS KIT P/N 07.9802.97.3 (OPTIONAL)

I dati riportati sono indicativi e non impegnativi, l'azienda si riserva di variarli in qualsiasi momento e senza alcun preavviso.
Due to our program of continuous product development, we reserve the right to alter specifications without notice